



1. Wir über uns/ Referenzen
2. Typenübersicht
3. SPEED  
3-teilige Schnellbauzarge
4. S-2  
2-teilige Zarge, nicht verstellbar
5. TELESCOP  
2-teilige verstellbare Zarge
6. SOLID  
1-teilige Zarge MW/Mauerwerk  
1-teilige Zarge GK/Trockenbauzarge
7. CORNER  
Eckzarge
8. BLOCK  
Blockzarge
9. THZ  
Turnhallenzarge
10. DESIGN  
G-LINE  
M-LINE
11. F-LINE  
Fingerschutzzarge
12. DOUBLE ACTING  
Pendeltürzarge
13. SLIDE  
Schiebetürzarge v.d.W.  
Schiebetürzarge i.d.N.  
Schiebetürzarge i.d.W.
14. E-MOTION  
Drehschiebetür
15. Verglasungsrahmen/  
Ganzglastür
16. Sonderelemente
17. Kämpferprofile/  
Glashalteleisten
18. Anwendungen/Optionals
19. Bandsysteme
20. Schlosssysteme  
und Verriegelungen
21. OTS / ITS
22. Oberfläche und Materialien
23. Allgemeine Informationen



1. l'azienda / Referenze
2. tipologia di casseporte
3. SPEED  
cassaporta in 3-pezzi per montaggio rapido
4. S-2  
cassaporta in due pezzi, non regolabile
5. TELESCOP  
cassaporta regolabile
6. SOLID  
cassaporta in un pezzo MW/muratura  
cassaporta in un pezzo GK/parete in cartongesso
7. CORNER  
cassaporta ad angolo
8. BLOCK  
cassaporta per montaggio in luce
9. THZ  
telaio speciale per palestra
10. DESIGN  
G-LINE  
M-LINE
11. F-LINE  
cassaporta antiinfortunistica
12. DOUBLE ACTING  
cassaporta per porta a Ventola
13. SLIDE  
scorrevole esterno parete  
scorrevole interno nicchia  
scorrevole interno parete
14. E-MOTION  
porta rototraslante
15. telai per vetrate/  
casseporte per porte in cristallo
16. elementi speciali
17. profili traversi/  
listelli fermavetro
18. applicazioni/optionals
19. sistemi di cerniere
20. sistemi di serrature e  
chiusure speciali
21. OTS / ITS
22. Materiali e superfici
23. informazioni tecniche  
generali



1. the company/References
2. typical frame elevations
3. SPEED  
3-part frame easy installation
4. S-2  
2-part frame, not adjustable
5. TELESCOP  
adjustable steel frame
6. SOLID  
1-part frame MW/concrete wall  
1-part frame GK/stud wall
7. CORNER  
corner frame
8. BLOCK  
frame for fixing flat in the wall
9. THZ  
special frame for sport halls
10. DESIGN  
G-LINE  
M-LINE
11. F-LINE  
frame with safety solution
12. DOUBLE ACTING  
double acting frame
13. SLIDE  
sliding door external wall  
sliding door - in wall niche  
sliding door - internal wall
14. E-MOTION  
rototraslation door system
15. steel frames for glazing/  
steel frame for glass doors
16. special frame elevations
17. transom bars/  
glazing beads
18. applications/optionals
19. hinge systems
20. lock and access systems
21. OTS / ITS
22. materials and surfaces
23. general technical  
informations



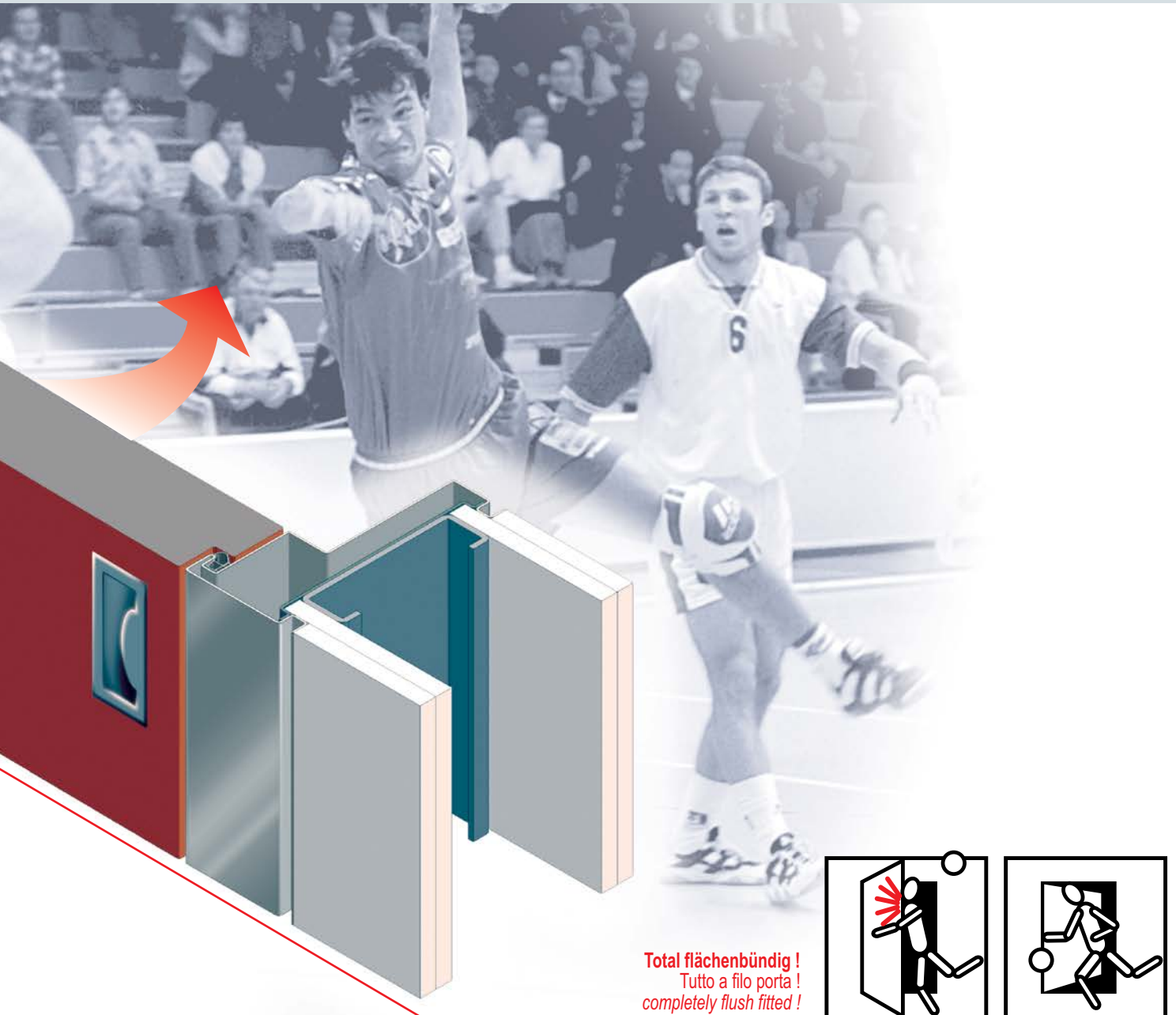

**Total flächenbündig !**  
 Tutto a filo porta !  
 completely flush fitted !

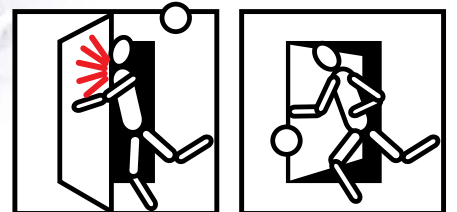

Diese Zargen sind besonders konstruiert um einen flächenbündigen Einbau mit Wand und Tür zu ermöglichen. Die Tür öffnet sich von einer Sporthalle immer nach außen um eventuelle Unfälle durch Kollision mit der Tür zu vermeiden. Als Türdrücker empfehlen wir die Verwendung von flächenbündigen Muschelgriffen.

rema THZ Zargen sind in folgenden Ausführungen lieferbar:

- für verschiedenste Wandanschlüsse mit oder ohne Schattennut
- Stahl pulverbeschichtet oder Edelstahl
- Große Farbauswahl
- Maßfertigung
- Für Schallschutz auch mit Doppelfalz

Questi telai sono disegnati specialmente per il montaggio conplanare con la parete e con l'anta. L'apertura della porta deve essere sempre verso il lato opposto della palestra per evitare incidenti causati da collisioni con la porta aperta. Consigliamo di utilizzare maniglie speciali a conchiglia per montaggio a filo dell'anta.

Casseporte rema THZ con disponibili nelle seguenti versioni:

- Fissaggio su vari tipi di costruzione di parete con o senza canalino coprifuga acciaio
- verniciato oppure acciaio inox.
- Vasta gamma di colori
- Costruzione su misura
- Per porte ad isolamento acustico con doppia battuta.

*This kind of steel frame has been designed for flat installation with wall and door leaf*  
*The door opening must be outside to avoid accidents in case of collision with open door.*

*rema recommends to use mussel handle for flat installation.*

**rema THZ frames are available as follow:**

- **Installation on many different types of wall constructions**
- **with or without shadow groove profile**
- **powder coated steel or stainless steel**
- **big range of colours and surfaces**
- **custom made sizes**
- **for sound proof doors with double rebated profil**

**rema Stahlzarge Modell THZ, Turnhallenzarge**  
**Ausführungsmöglichkeit :**

als SOLID-Zarge  
als S2 2-teilige Zarge  
als TELESCOP - Zarge  
Zarge durchgehend verschweißt

Profil ..... (Auswahl aus rema Profilvariante)  
für stumpfes Türblatt; Türblattstärke (TS)...mm  
für doppelt gefälztes Türblatt (FT1) ...mm (FT2)...mm

Material: verzinktes Stahlblech 1,5mm oder 2,0mm  
bzw. Edelstahl V2A oder V4A 1,5mm  
oder 2,0mm

Oberfläche: pulvergrundiert für bauseitigen  
Anstrich bzw. fertig  
pulverbeschichtet nach RAL....  
oder bei Edelstahl geschliffen K220  
bzw. gebürstet Scotch Brite

Hohlkammerdichtung C1397 grau oder schwarz

2 oder mehr Bandunterkonstruktionen Modell ...

verstellbares rema Edelstahlschliessblech mit  
Mauerschutzkasten

Wandbefestigung je nach gewähltem Zargentyp

**telaio rema modello THZ, telaio speciale per**  
**palestra esecuzione:**

telaio SOLID  
telaio S2  
telaio TELESCOP  
telaio con angoli saldati

profilo ..... (scelta della gamma di profili rema)  
per porta a filo; spessore pannello (TS)...mm  
per porta a doppia battuta (FT1) ...mm (FT2)...mm

materiale: Lamiera zincata 1,5mm oppure 2,0mm  
oppure lamiera INOX AISI304  
oppure AISI316 spessore 1,5mm  
oppure 2,0mm

superficie: verniciato a mano di fondo Primer,  
oppure verniciato a polveri RAL  
per telaio Inox satinato Scotch Brite  
oppure K220

guarnizione C1397 grigio oppure nero

2 oppure più predisposizioni per cerniera modello ...

incontro serratura regolabile rema in acciaio Inox

fissaggio adatto per tipo telaio scelto

**rema steel frame model THZ, special frame for**  
**sport halls executions:**

*SOLID Frame*  
*S2 frame*  
*TELESCOP frame*  
*frame with welded corners or*

*profile ..... (choose from the rema profile range)*  
*for flush door; leaf thickness (TS)...mm*  
*for double rebated door (FT1) ...mm (FT2)...mm*

*material: galvanized steel sheet 1,5mm*  
*or 2,0mm or Stainless steel sheet V2A*  
*or V4A 1,5mm or 2,0mm*

*surface: powder coated PRIMER,*  
*or finished powder coated RAL*  
*for stainless steel satinated K220*  
*or Scotch Brite*

*rubber seal C1397 grey or black*

*2 or more hinge preps for model...*

*adjustable rema stainless steel lock strike plate*

*fixing as frame type, requires*

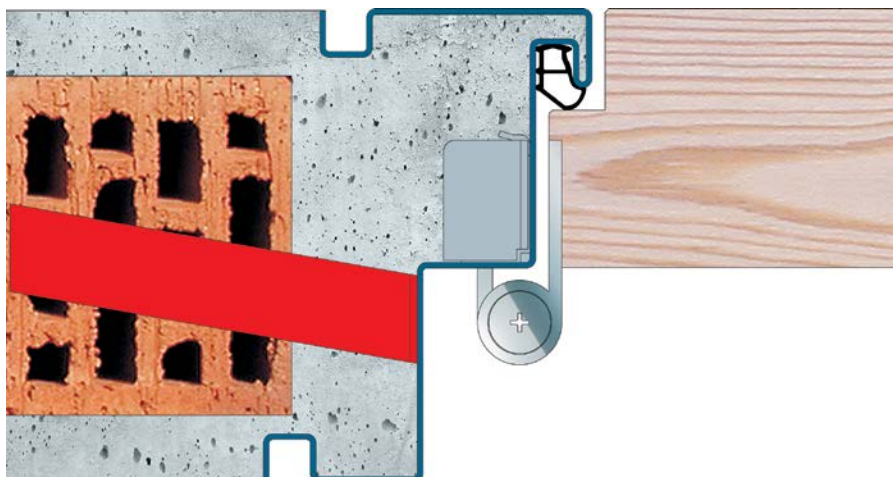

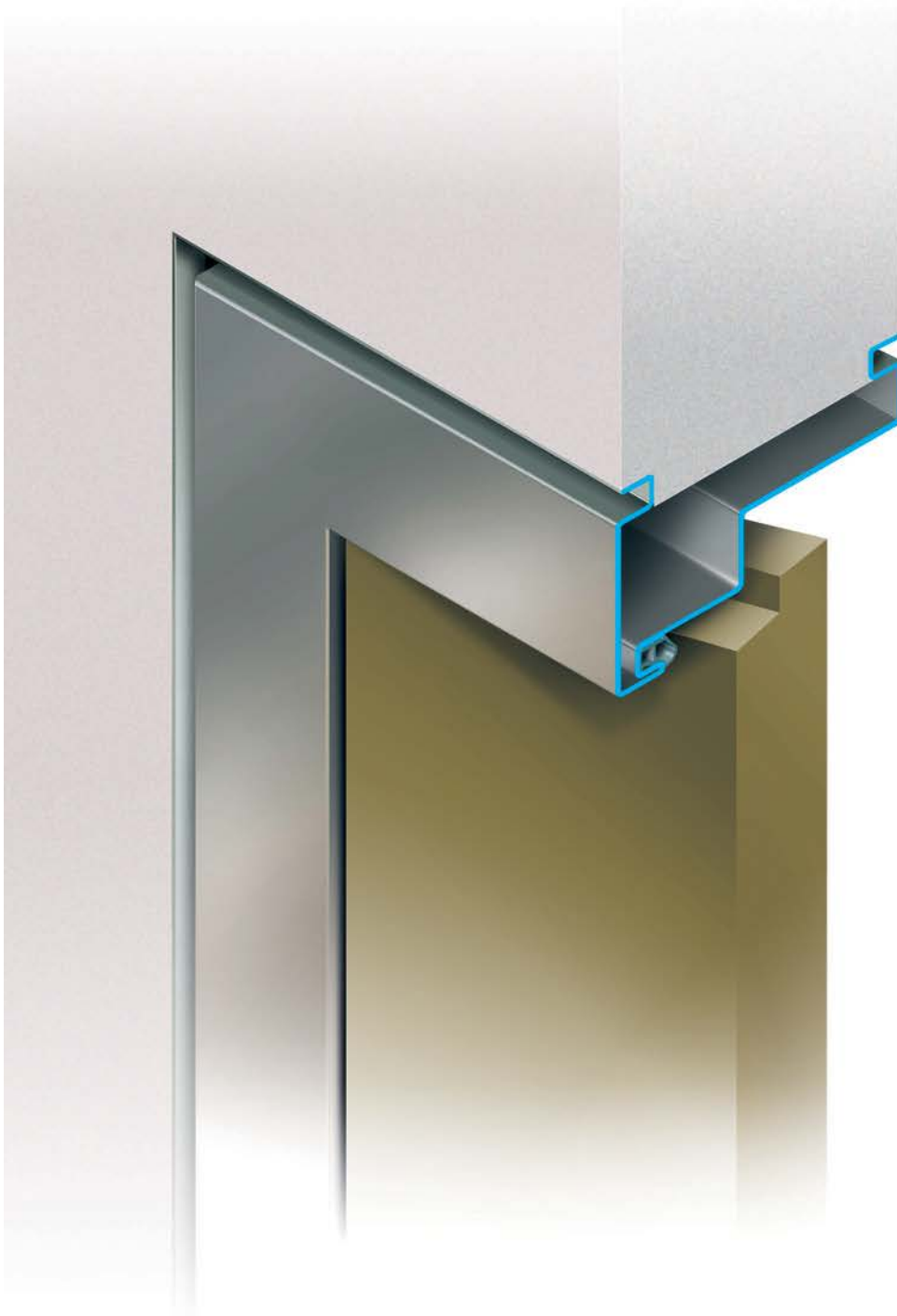

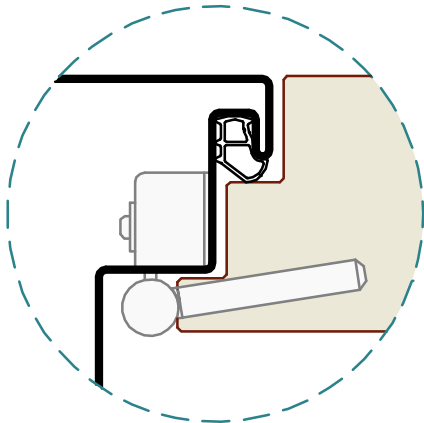

**doppelt gefälztes Türblatt**  
 porta a doppia battuta  
 double rebated door

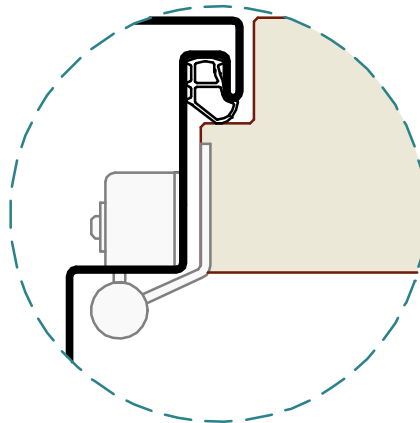

**stumpf gefälztes Türblatt**  
 porta a filo con battuta  
 flush rebated door

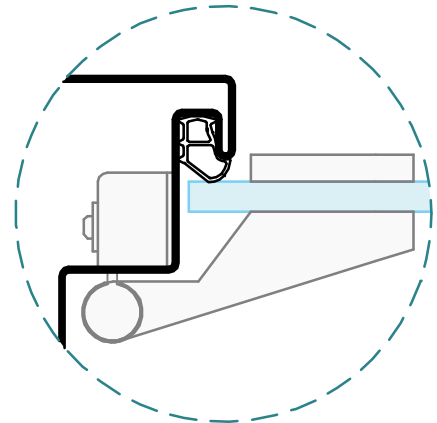

**Ganzglastür**  
 porta in cristallo  
 glass door

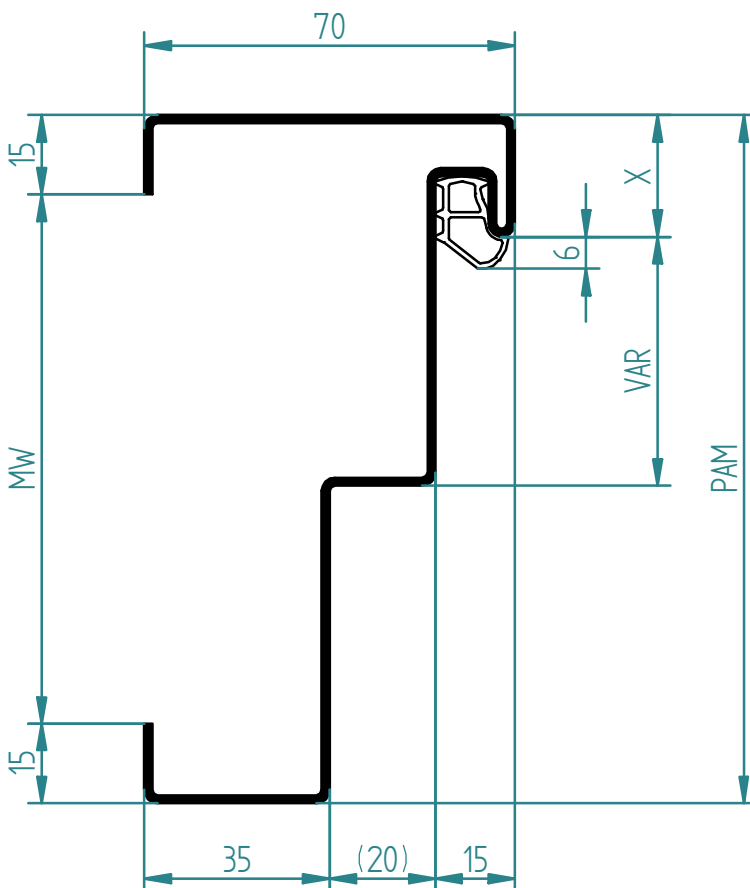

**Befestigung mit Maueranker**  
 fissaggio con zanca a muro  
 fitting with anchor for concrete

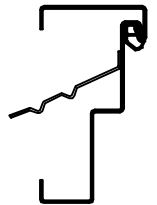

**Befestigung mit Hutanker**  
 fissaggio con staffa ad "U"  
 fitting with "U" bracket

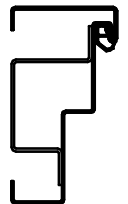

X = min. 23mm (15/10)  
 X = min. 29mm (20/10)

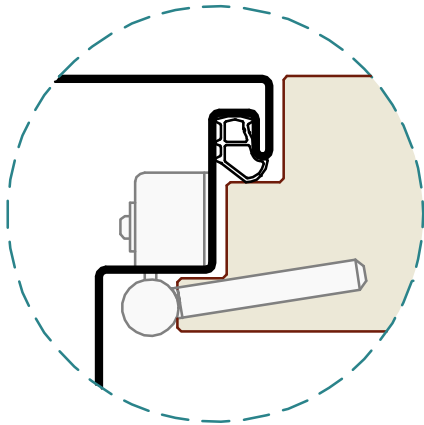

**doppelt gefälztes Türblatt**  
 porta a doppia battuta  
 double rebated door

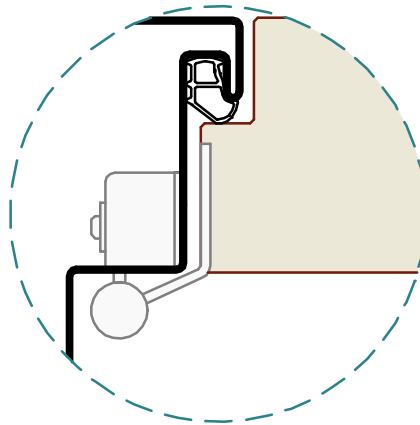

**stumpf gefälztes Türblatt**  
 porta a filo con battuta  
 flush rebated door

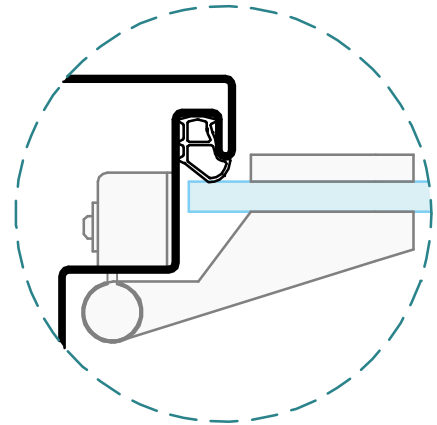

**Ganzglastür**  
 porta in cristallo  
 glass door

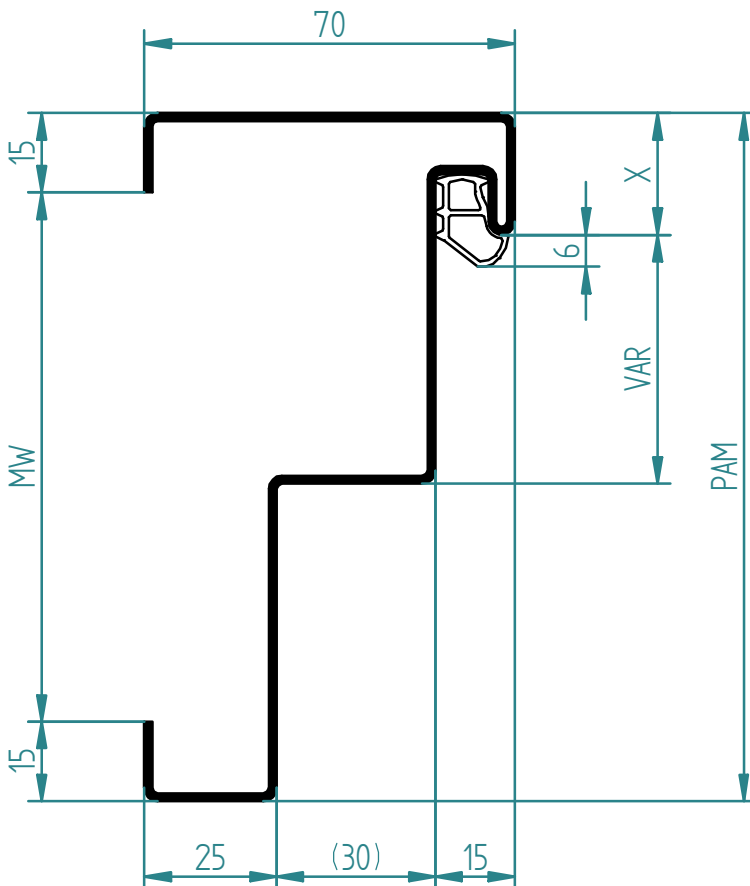

**Befestigung mit Maueranker**  
 fissaggio con zanca a muro  
 fitting with anchor for concrete

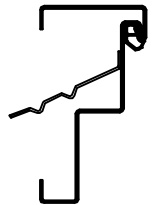

**Befestigung mit Hutanker**  
 fissaggio con staffa ad "U"  
 fitting with "U" bracket

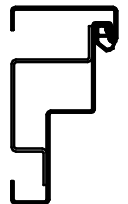

X = min. 23mm (15/10)  
 X = min. 29mm (20/10)

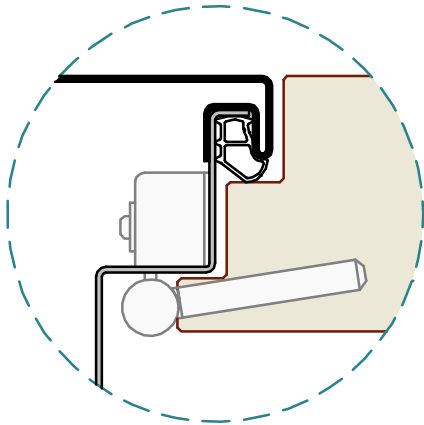

**doppelt gefälztes Türblatt**  
 porta a doppia battuta  
 double rebated door

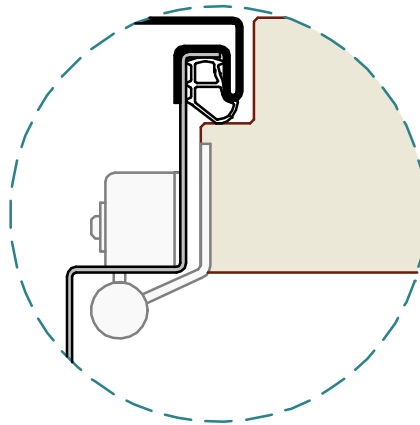

**stumpf gefälztes Türblatt**  
 porta a filo con battuta  
 flush rebated door

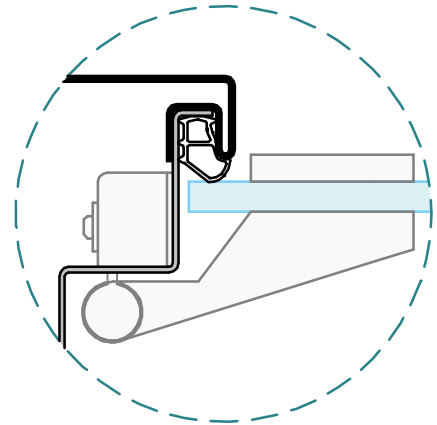

**Ganzglastür**  
 porta in cristallo  
 glass door

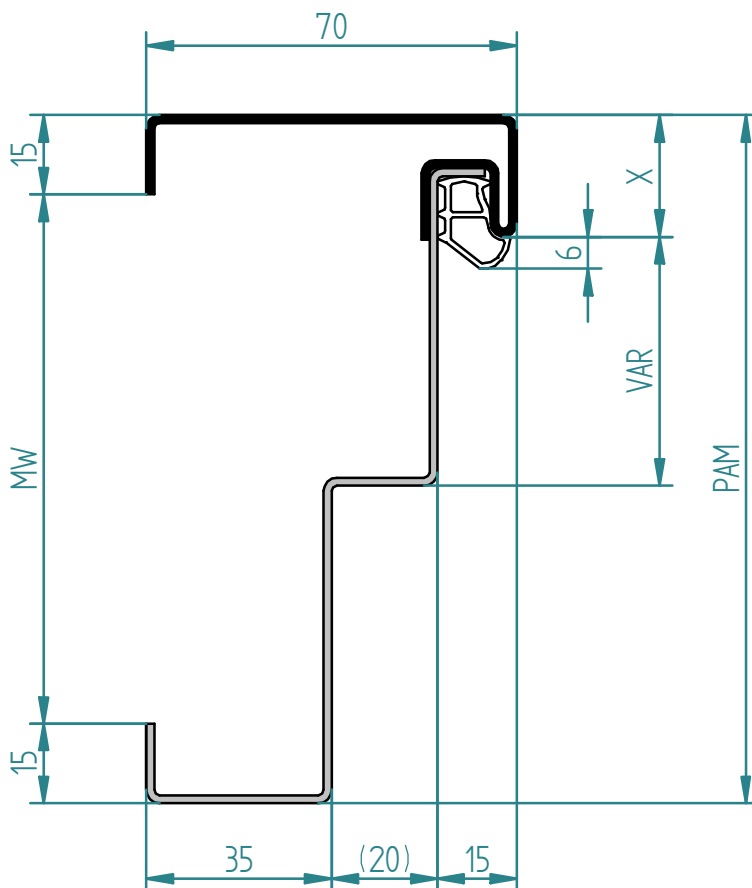

**Befestigung mit Hutanker**  
 fissaggio con staffa ad "U"  
 fitting with "U" bracket

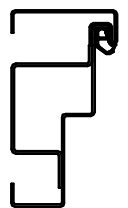

X = min. 23mm (15/10)  
 X = min. 29mm (20/10)



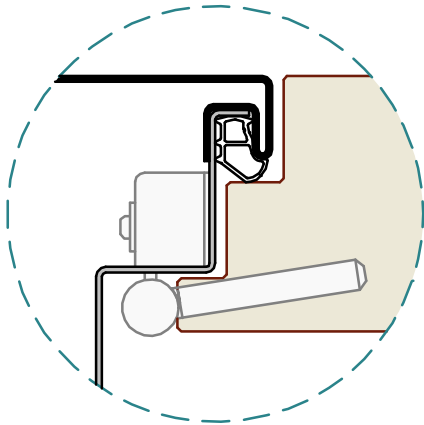

**doppelt gefälztes Türblatt**  
 porta a doppia battuta  
 double rebated door

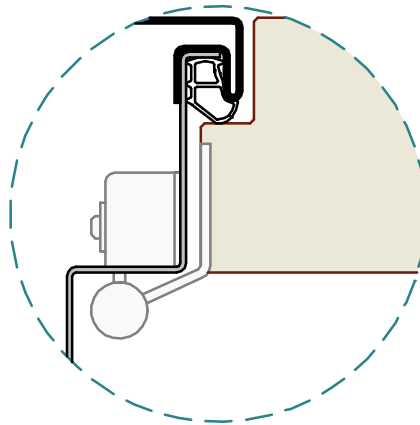

**stumpf gefälztes Türblatt**  
 porta a filo con battuta  
 flush rebated door

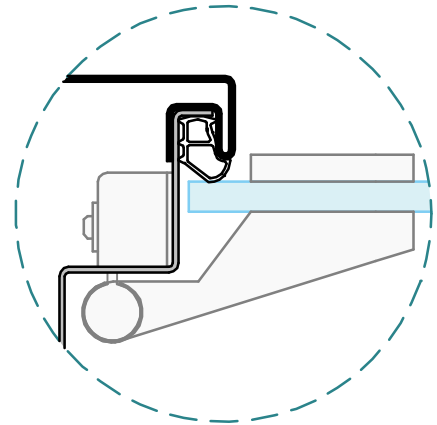

**Ganzglastür**  
 porta in cristallo  
 glass door

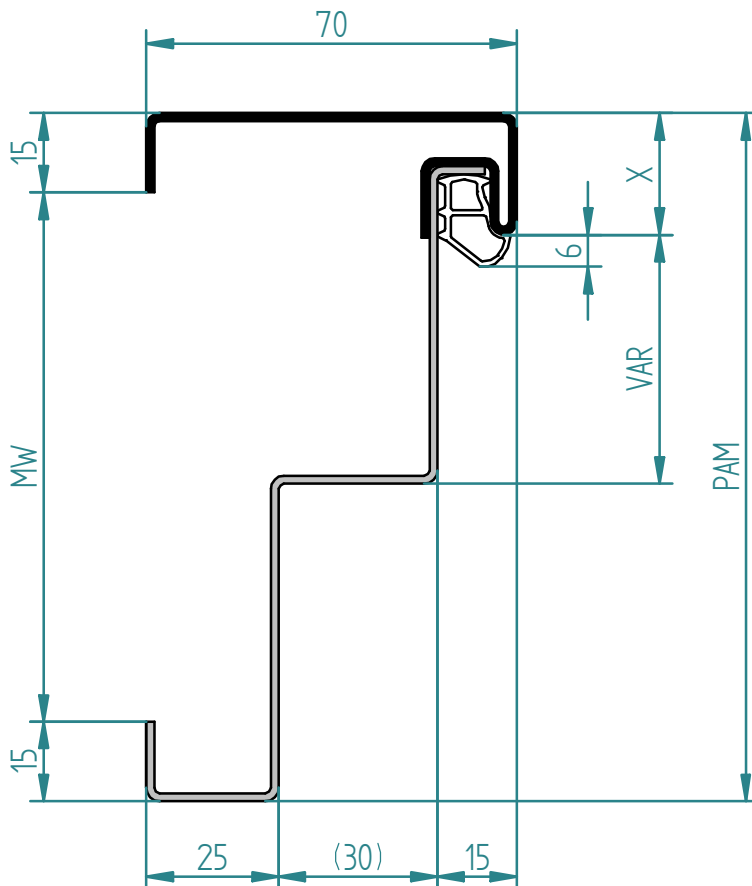

**Befestigung mit Hutanker**  
 fissaggio con staffa ad "U"  
 fitting with "U" bracket

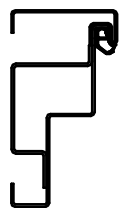

X = min. 23mm (15/10)  
 X = min. 29mm (20/10)

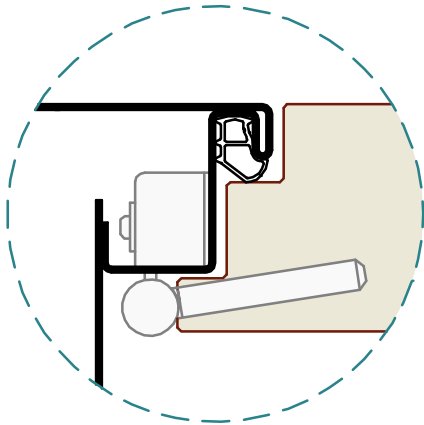

**doppelt gefälztes Türblatt**  
 porta a doppia battuta  
 double rebated door

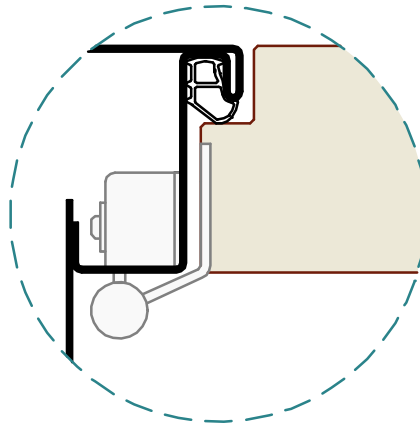

**stumpf gefälztes Türblatt**  
 porta a filo con battuta  
 flush rebated door

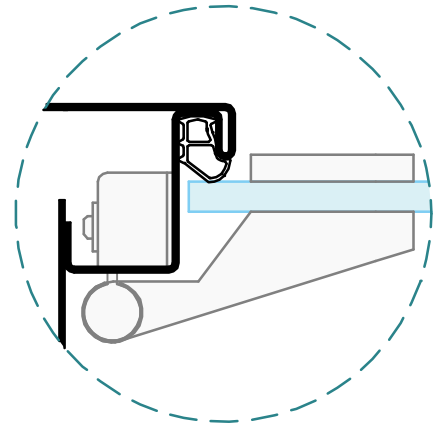

**Ganzglastür**  
 porta in cristallo  
 glass door

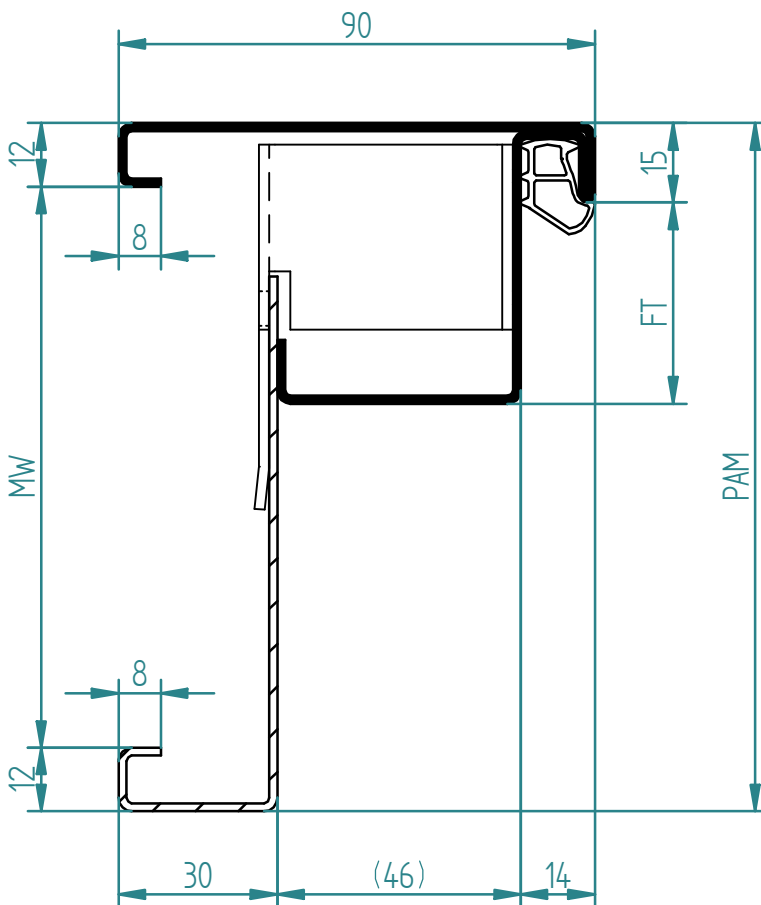

**Befestigung mit Befestigungslasche**  
 fissaggio con staffa di fissaggio  
 fitting with fixing-bracket

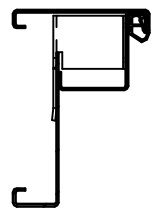

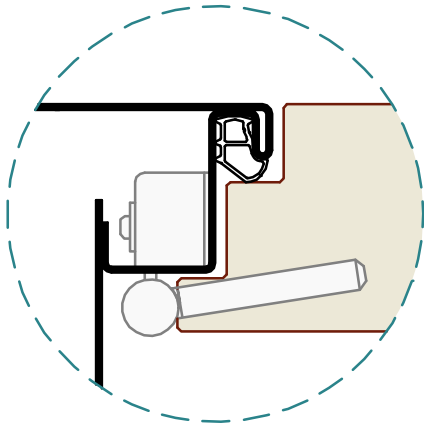

**doppelt gefälztes Türblatt**  
 porta a doppia battuta  
 double rebated door

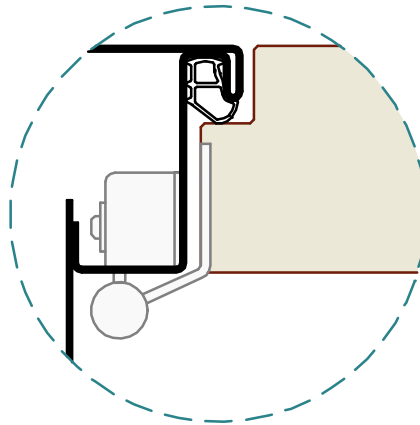

**stumpf gefälztes Türblatt**  
 porta a filo con battuta  
 flush rebated door

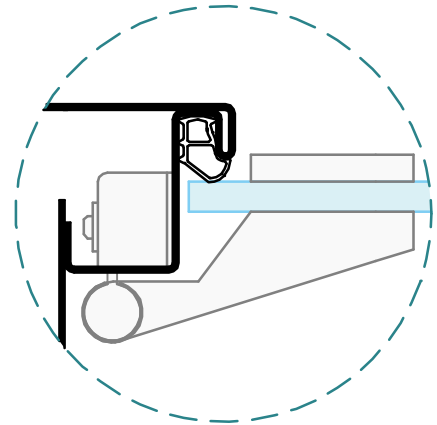

**Ganzglastür**  
 porta in cristallo  
 glass door

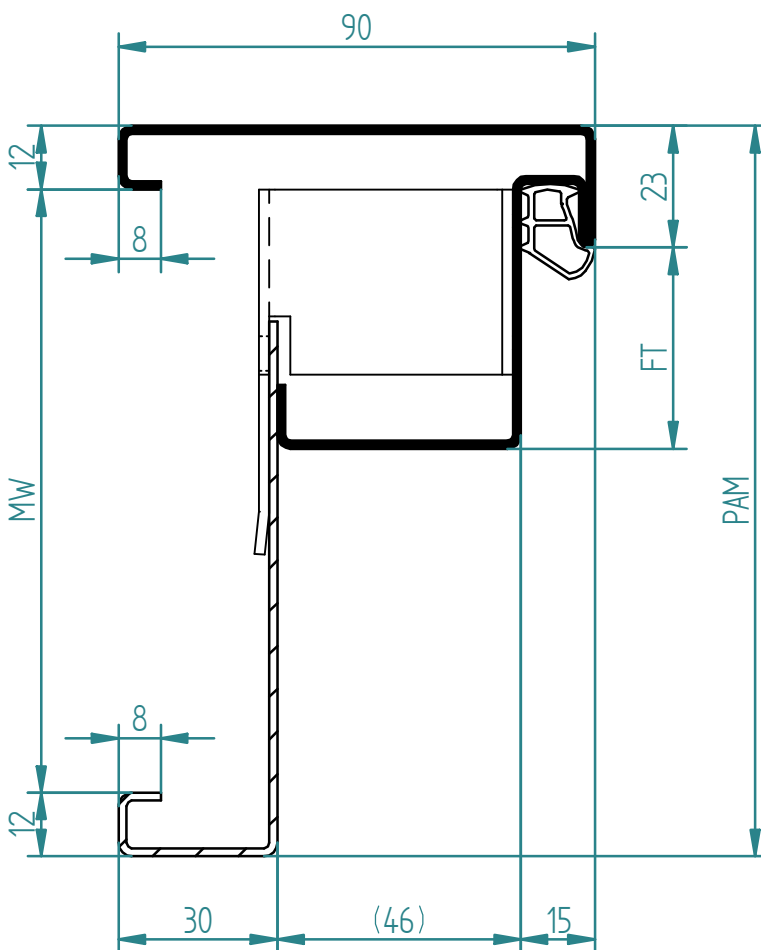

**Befestigung mit Befestigungslasche**  
 fissaggio con staffa di fissaggio  
 fitting with fixing-bracket

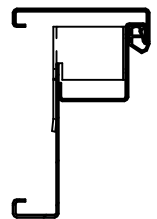

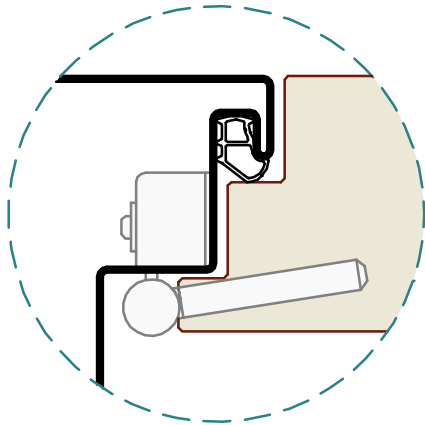

**doppelt gefälztes Türblatt**  
 porta a doppia battuta  
 double rebated door

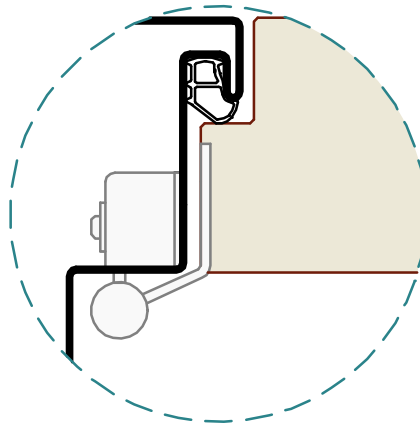

**stumpf gefälztes Türblatt**  
 porta a filo con battuta  
 flush rebated door

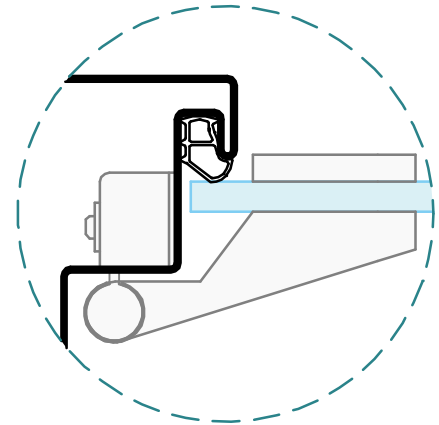

**Ganzglastür**  
 porta in cristallo  
 glass door

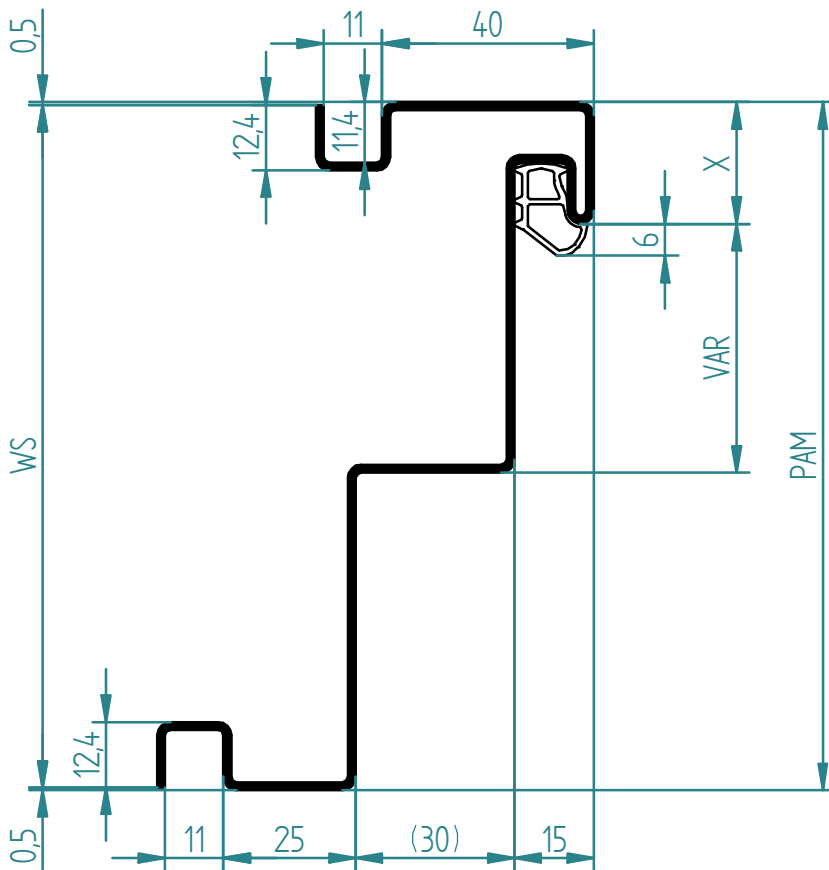

**Befestigung mit Maueranker**  
 fissaggio con zanca a muro  
 fitting with anchor for concrete

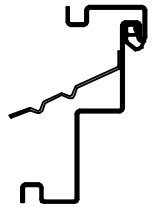

**Befestigung mit Hutanker**  
 fissaggio con staffa ad "U"  
 fitting with "U" bracket

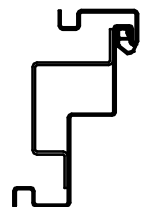

X = min. 23mm (15/10)  
 X = min. 29mm (20/10)



Via stazione 22/A, I-39035 Mongueifo (BZ)  
 Tel. +39 0474 947 200, Fax 947 299  
 www.rema-online.it E-mail info@rema-online.it

THZ

<b>Kunde:</b>	<b>Lieferung:</b>	
Anschrift:	Kunde bzw. Baustelle:	
UID.Nr.		
Tel.:	Fax.:	
e-mail		
Kontaktperson:	e-mail	
Projekt:	Tel.:	Fax.:
Gewünschter Liefertermin KW:	Kontaktperson:	Mobil:

<p><b>1.) Material</b>                  ___ 1,5 mm verzinktes Stahlblech                  ___ 2,0 mm verzinktes Stahlblech                  ___ Edelstahl V2A 1,5 mm SB                  ___ Edelstahl V4A 1,5 mm SB                  ___ andere _____</p> <p><b>2.) Oberfläche</b>                  ___ roh                  ___ pulvergrundiert (RAL 9010)                  ___ pulverbeschichtet RAL _____                  ___ glatt-glänzend                  ___ glatt-matt                  ___ Feinstruktur-seidenglänzend                  ___ Feinstruktur-matt                  ___ andere _____</p> <p><b>3.) Falzausführung Türblatt</b>                  ___ gefälzt 25,5 mm oder _____                  ___ stumpf 40 mm oder _____                  ___ Doppelfalz überfälzt FT1 _____ FT2 _____                  ___ Doppelfalz stumpf FT1 _____ FT2 _____                  ___ Glastürblatt _____ (8-10)</p> <p><b>4.) Bandaufnahme</b>                  ___ V8600                  ___ VX 7511 3D                  ___ VN 7608 120 3D                  ___ VN 7608 160 3D                  ___ andere _____</p>	<p><b>5.) Bandbezugslinien</b>                  ___ 1.BBL 241 mm      2.BBL 1435 mm                  ___ 1.BBL 241 mm      2.BBL 1560 mm                  ___ 1.BBL _____ mm      2.BBL _____ mm                  ___ 3.BBL _____ mm      3.BBL 250 mm                  ___ 3.BBL mittig _____      ___ 4.BBL _____ mm</p> <p><b>6.) Schlossstanzung</b>                  ___ 62-23-62 mit verstellbarem Schliessblech                  ___ andere _____</p> <p><b>7.) Schlossstiefe (ST)</b>                  ___ gefälzt ST=4 mm      oder _____ mm                  ___ stumpf ST=15,5 mm      oder _____ mm</p> <p><b>8.) Schlosshöhe (SH)</b>                  ___ 1050 mm                  ___ andere _____</p> <p><b>9.) Befestigung</b>                  ___ Maueranker für Beton / Mauerwerk                  ___ Hutanker für Gipskartonmontage                  ___ Klemmbügel und Rapid Block für SPEED                  ___ verstellbare Universallasche für TELESCOP / S2                  ___ andere _____</p> <p><b>10.) Kämpferprofil für Oberlichte</b>                  ___ ja      ___ nein                  ___ Kämpferprofil ALUMINIUM 45-75                  ___ Kämpferprofil STAHL gekantet: Profiltyp _____</p>	<p><b>11.) Glasleistenprofil für Oberlichte</b>                  ___ Aluminiumglasleiste 15x15mm zum Aufklipsen                  ___ Profilirhrglasleiste ___x15mm zum Aufschrauben                  ___ andere _____</p> <p><b>12.) Glasstärke für Oberlichte</b>                  ___ mm</p> <p><b>13.) Dichtungstyp C 1397</b>                  ___ grau                  ___ schwarz                  ___ weiss                  ___ braun</p> <p><b>14.) Bodeneinstand (BE)</b>                  ___ ohne                  ___ mit: _____ mm</p> <p><b>15.) Extras</b>                  ___ ohne                  ___ mit: _____</p> <p><b>16.) Bandlieferung</b>                  ___ ja      ___ nein                  Bandtyp _____</p> <p><b>17.) Zeichnungen</b>                  ___ ja      ___ nein                  Zeichnungsnr.: _____</p>
--	---	--

pos.	Profiltyp	MW	Wandöffnungsmass : RBB / RBH		Kämpferhöhe für Oberlichte	Öffnungsrichtung DIN		2 flg.	ges. Stückz.	EXTRAS	Preis
			Zargenfalzmass : DB / DH	FH / FB		L	R				
			Breite	Höhe	DKH						

Auftragsnr. \_\_\_\_\_ Datum: \_\_\_\_\_ Unterschrift: \_\_\_\_\_



Via stazione 22/A, I-39035 Monguefio (BZ)  
Tel. +39 0474 947 200, Fax 947 299  
www.rema-online.it E-mail info@rema-online.it

**THZ**

<b>cliente:</b>	<b>spedizione:</b>	
indirizzo:	cliente opp. cantiere:	
P. IVA:		
Tel.:	Fax.:	
e-mail		
Persona di contatto:	e-mail	
Progetto:	Tel.:	Fax.:
Consegna richiesta: _____	Persona di contatto:	cellulare:

<p><b>1.) materiale</b>  <input type="checkbox"/> lamiera zincata 1,5 mm  <input type="checkbox"/> lamiera zincata 2,0 mm  <input type="checkbox"/> acciaio INOX AISI 304 1,5 mm  <input type="checkbox"/> acciaio INOX AISI 316 1,5 mm  <input type="checkbox"/> altri _____</p> <p><b>2.) superficie</b>  <input type="checkbox"/> zincata  <input type="checkbox"/> con mano di fondo (RAL 9010)  <input type="checkbox"/> verniciato a polveri RAL _____  <input type="checkbox"/> liscio - lucido  <input type="checkbox"/> liscio - opaco  <input type="checkbox"/> raggrinz. - semilucido  <input type="checkbox"/> raggrinz. - opaco  <input type="checkbox"/> altri _____</p> <p><b>3.) esecuzione battuta</b>  <input type="checkbox"/> porta con battuta 25,5 mm o _____  <input type="checkbox"/> porta senza battuta 40 mm o _____  <input type="checkbox"/> porta a doppia battuta FT1 _____ FT2 _____  <input type="checkbox"/> porta a filo con battuta FT1 _____ FT2 _____  <input type="checkbox"/> porta in cristallo _____ (8-10)</p> <p><b>4.) predisposizione per cerniere</b>  <input type="checkbox"/> V8600  <input type="checkbox"/> VX 7511 3D  <input type="checkbox"/> VN 7608 120 3D  <input type="checkbox"/> VN 7608 160 3D  <input type="checkbox"/> altri _____</p>	<p><b>5.) posizionamento cerniere</b>  <input type="checkbox"/> 1.BBL 241 mm      2.BBL 1435 mm  <input type="checkbox"/> 1.BBL 241 mm      2.BBL 1560 mm  <input type="checkbox"/> 1.BBL _____ mm      2.BBL _____ mm  <input type="checkbox"/> 3.BBL _____ mm      3.BBL 250 mm  <input type="checkbox"/> 3.BBL centrale      4.BBL _____ mm</p> <p><b>6.) foro serratura</b>  <input type="checkbox"/> 62-23-62 con incontro serratura regolabile  <input type="checkbox"/> altri _____</p> <p><b>7.) profondità serratura ( ST )</b>  <input type="checkbox"/> per porta con battuta ST=4 mm      o _____ mm  <input type="checkbox"/> per porta senza battuta ST=15,5 mm      o _____ mm</p> <p><b>8.) altezza serratura ( SH )</b>  <input type="checkbox"/> 1050 mm  <input type="checkbox"/> altri _____</p> <p><b>9.) sistema di ancoraggio</b>  <input type="checkbox"/> zanche da murare per cemento  <input type="checkbox"/> staffe per fissaggio per parete in cartongesso  <input type="checkbox"/> morsetto e Rapid Block per SPEED  <input type="checkbox"/> staffa universale regolabile per TELESCOP / S2  <input type="checkbox"/> altri _____</p> <p><b>10.) profilo traverso per sopra lucce</b>  <input type="checkbox"/> sì _____ no  <input type="checkbox"/> profilo traverso in alluminio 45-75  <input type="checkbox"/> profilo traverso piegato in acciaio: tipo _____</p>	<p><b>11.) fermavetro per sopra lucce</b>  <input type="checkbox"/> fermavetro-clip 15x15mm in alluminio  <input type="checkbox"/> fermavetro tubolare _____x15mm per avvitare  <input type="checkbox"/> altri _____</p> <p><b>12.) spessore vetro per sopra lucce</b>          _____mm</p> <p><b>13.) tipo di guarnizione C 1397</b>  <input type="checkbox"/> grigio  <input type="checkbox"/> nero  <input type="checkbox"/> bianco  <input type="checkbox"/> marrone</p> <p><b>14.) incasso nel pavimento ( BE )</b>  <input type="checkbox"/> senza  <input type="checkbox"/> con: _____mm</p> <p><b>15.) Extras</b>  <input type="checkbox"/> senza  <input type="checkbox"/> con: _____</p> <p><b>16.) fornitura cerniere</b>  <input type="checkbox"/> sì _____ no          tipo cerniera _____</p> <p><b>17.) disegni</b>  <input type="checkbox"/> sì _____ no          disegno nr.: _____</p>
---	--	--

pos.	tipo del profilo	MW	larghezza	altezza	DHK	senso di apertura DIN		2 ante	quantità totale	EXTRAS	prezzo
						L	R				

ordine nr. \_\_\_\_\_ data: \_\_\_\_\_ firma del cliente: \_\_\_\_\_



Via stazione 22/A, I-39035 Monguefio (BZ)  
 Tel. +39 0474 947 200, Fax 947 299  
 www.rema-online.it E-mail info@rema-online.it

**THZ**

<b>Client:</b>	<b>Destination:</b>
Adress:	site or client adress:
VAT No.:	
Tel.:	Fax. :
e-mail	
Contact:	e-mail
Project:	Tel.:
Requested delivery date: _____	Fax. :
	Contact:
	Mobile:

<p><b>1.) Material</b>  <input type="checkbox"/> galvanized steel 1,5 mm  <input type="checkbox"/> galvanized steel 2,0 mm  <input type="checkbox"/> stainless steel AISI 304 1,5 mm  <input type="checkbox"/> stainless steel AISI 316 1,5 mm  <input type="checkbox"/> others _____</p> <p><b>2.) Surface</b>  <input type="checkbox"/> raw  <input type="checkbox"/> primed ( RAL 9010 )  <input type="checkbox"/> powder coated RAL _____  <input type="checkbox"/> smooth-glossy  <input type="checkbox"/> smooth-matte  <input type="checkbox"/> finetexture-semigloss  <input type="checkbox"/> finetexture-matte  <input type="checkbox"/> others _____</p> <p><b>3.) Doortype</b>  <input type="checkbox"/> rebated 25,5 mm or _____  <input type="checkbox"/> flush door 40 mm or _____  <input type="checkbox"/> double rebated FT1 _____ FT2 _____  <input type="checkbox"/> double rebated flush door FT1 _____ FT2 _____  <input type="checkbox"/> glass door _____ ( 8-10 )</p> <p><b>4.) Hinge preparing</b>  <input type="checkbox"/> V8600  <input type="checkbox"/> VX 7511 3D  <input type="checkbox"/> VN 7608 120 3D  <input type="checkbox"/> VN 7608 160 3D  <input type="checkbox"/> others _____</p>	<p><b>5.) Hinge positions</b>  <input type="checkbox"/> 1.BBL 241 mm      2.BBL 1435 mm  <input type="checkbox"/> 1.BBL 241 mm      2.BBL 1560 mm  <input type="checkbox"/> 1.BBL _____ mm      2.BBL _____ mm  <input type="checkbox"/> 3.BBL _____ mm      3.BBL 250 mm  <input type="checkbox"/> 3.BBL central _____      4.BBL _____ mm</p> <p><b>6.) Lock preparing</b>  <input type="checkbox"/> 62-23-62 con with registrable strike plate  <input type="checkbox"/> others _____</p> <p><b>7.) Depth of lock preparing ( ST )</b>  <input type="checkbox"/> for rebated door ST=4 mm      or _____ mm  <input type="checkbox"/> fur flush door ST=15,5 mm      or _____ mm</p> <p><b>8.) Hight of lock preparing ( SH )</b>  <input type="checkbox"/> 1050 mm  <input type="checkbox"/> others _____</p> <p><b>9.) Fixing systems</b>  <input type="checkbox"/> special brackets for concrete walls  <input type="checkbox"/> special anchors for stud walls  <input type="checkbox"/> clamb and Rapid Block for SPEED  <input type="checkbox"/> regolable anchor for TELESCOP / S2  <input type="checkbox"/> others _____</p> <p><b>10.) Transom-bar for overlight frame</b>  <input type="checkbox"/> yes      _____ no  <input type="checkbox"/> transom in aluminium 45-75  <input type="checkbox"/> bended transom in steel : type _____</p>	<p><b>11.) Glazing bead for fanlight</b>  <input type="checkbox"/> clip bead 15x15mm in aluminium  <input type="checkbox"/> steel tube bead _____x15mm to screw  <input type="checkbox"/> others _____</p> <p><b>12.) Glass thickness for fanlight</b>      _____ mm</p> <p><b>13.) Color of rubber seal C 1397</b>  <input type="checkbox"/> grey  <input type="checkbox"/> black  <input type="checkbox"/> white  <input type="checkbox"/> brown</p> <p><b>14.) Floor height ( BE )</b>  <input type="checkbox"/> no  <input type="checkbox"/> yes: _____ mm</p> <p><b>15.) Extras</b>  <input type="checkbox"/> no  <input type="checkbox"/> yes: _____</p> <p><b>16.) Hinge supply</b>  <input type="checkbox"/> yes      _____ no      hinge type _____</p> <p><b>17.) Drawings</b>  <input type="checkbox"/> yes      _____ no      drawing nr.: _____</p>
--	---	--

pos.	profile type	MW	<input type="checkbox"/> wall opening : RBB / RBH <input type="checkbox"/> frame-rebate dimension : FB / FH <input type="checkbox"/> open size of frame : DB / DH		height of transom for fanlight	handing DIN		2 doors	quantity total	EXTRA	price
			widht	height		DHK	L				

order nr. \_\_\_\_\_ date: \_\_\_\_\_ signature : \_\_\_\_\_

